

# Towel Folder with 3 Sorting Stackers

TOTOFOLDER 

## TB-100F

### Specifications & Dimensions

Model Number	TB-100F
Power Supply	200VAC 3Phase
Electric capacity	3.09kW
Air consumption	0.7MPa 250L/min.
Weight	2300KG

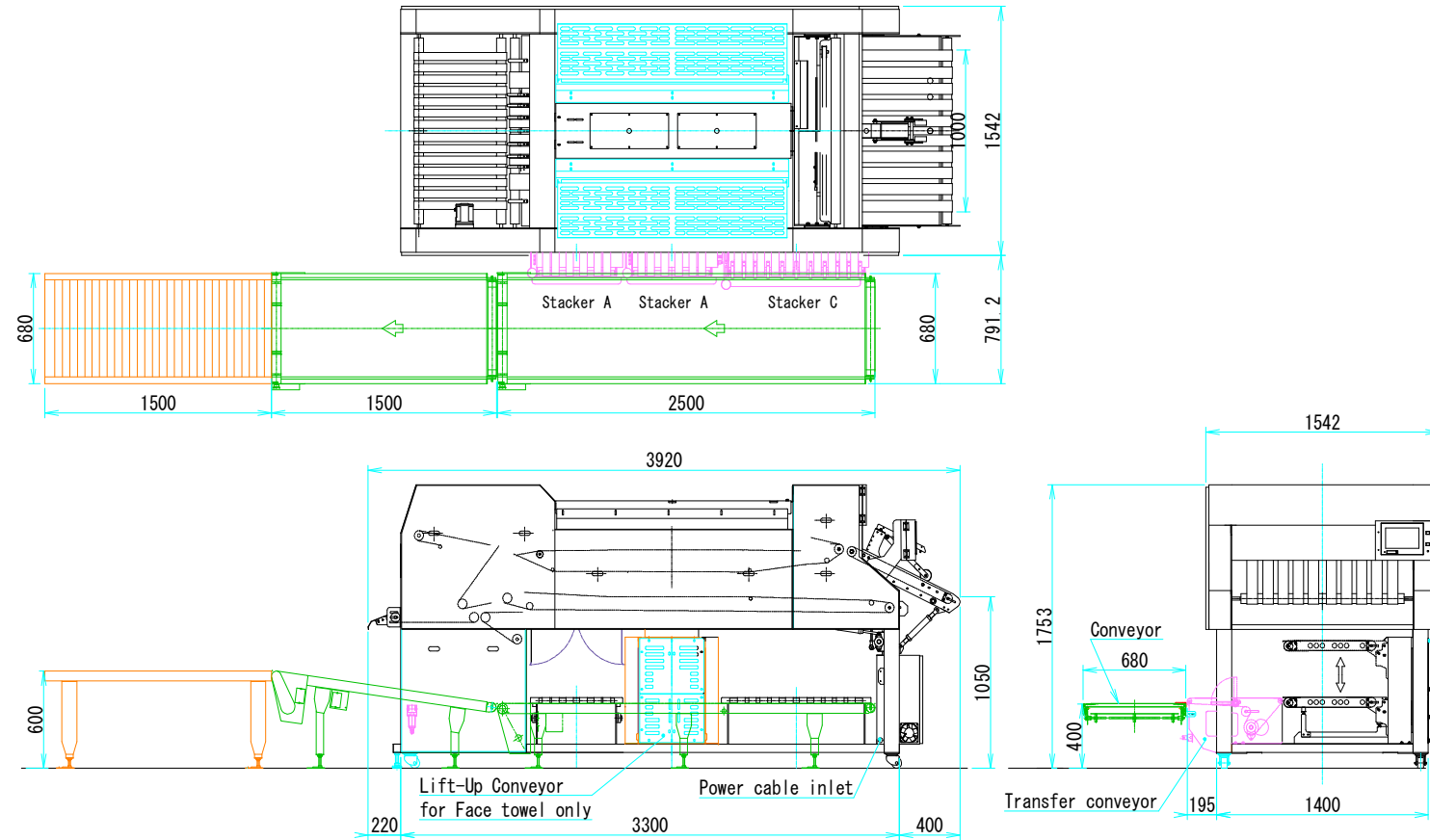

\*For better performances, specifications are subject to change without any prior notice.

### Application

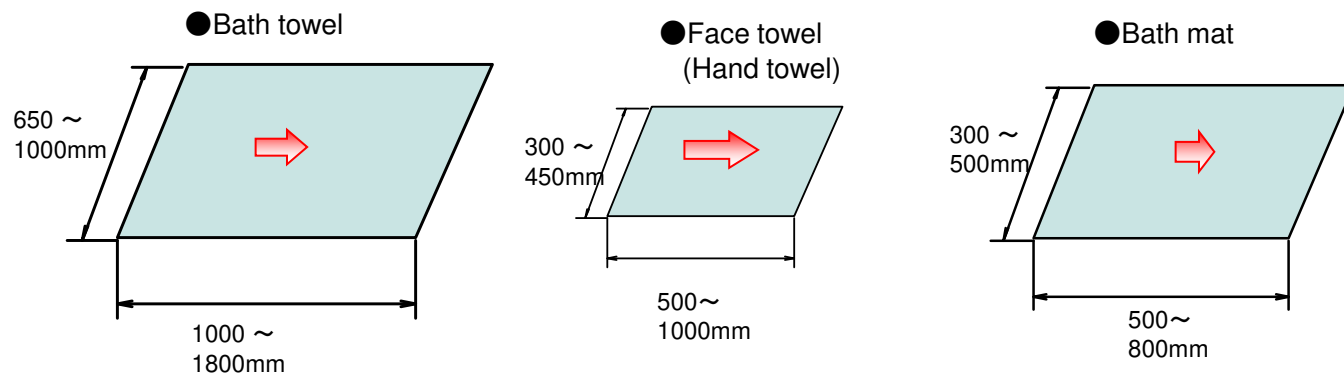

TOTO FOLDER MANUFACTURING CO., LTD.

3730, Iwatsuki, Iwatsuki-ku, Saitama-shi, Saitama 339-0061 Japan  
Phone: +81-48-757-0815 Fax: +81-48-758-2271

Sales Agent

'09.2

TOTOFOLDER 

# TB-100F

Towel Folder with 3 Sorting Stackers



**TOTO FOLDER MANUFACTURING CO., LTD.**

# Multi function Towel Folder with 3 sorting Stackers

Pre-sorting for Face towel ,Bath towel and Bath mat is not needed.



When feeding towel, towel size(face towel , bath towel and bath mat) is recognized automatically. Folding is made according to each parameters for face towel, bath towel and bath mat. After folding, each towels are stacked with sorting by type of towel.

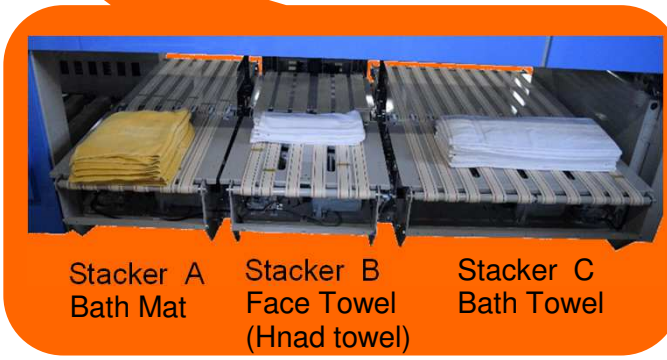

## Folding specifications

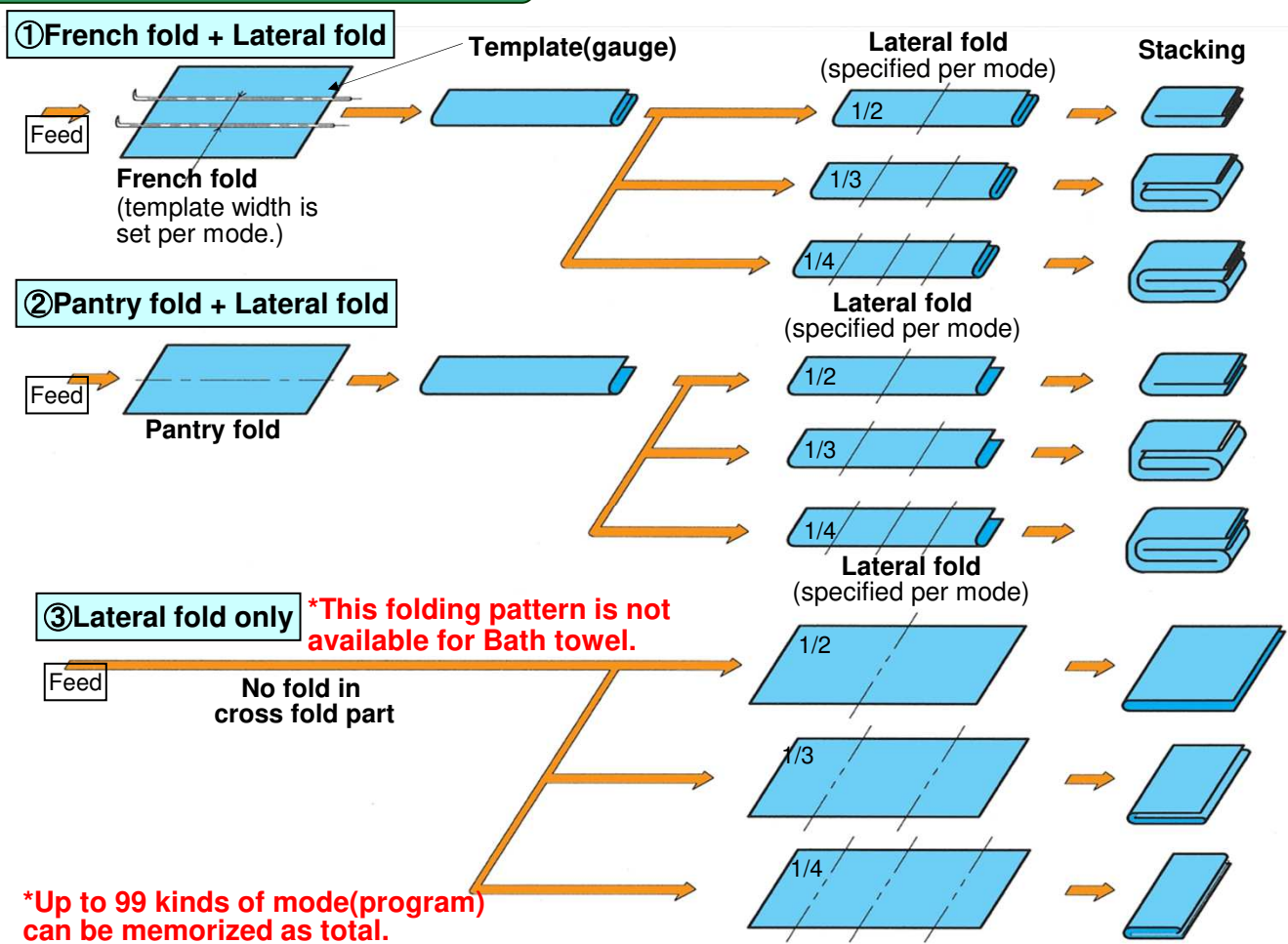

\*Up to 99 kinds of mode(program) can be memorized as total.

## Features of French fold

By using rigid stainless steel template(gauge) for French fold, beautiful French fold is obtainable. In addition, by adapting servo motor for controlling template width, template width can be specified accurately, immediately after sensing the article width.

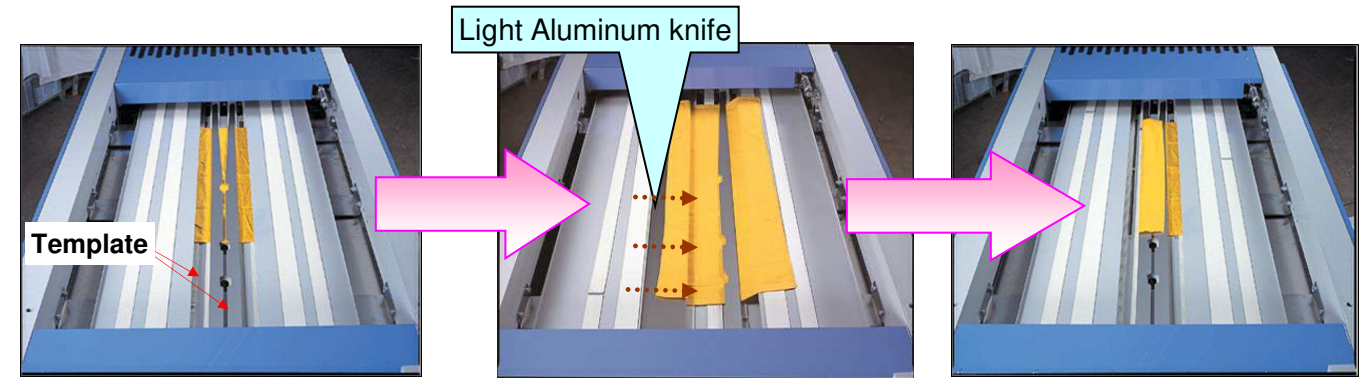

For large and thick towel, folding by Aluminum knife is suitable. For small and hard towel, folding by Aluminum knife and air blow is more suitable. Thus, in accordance with characteristics of towel, accurate and suitable folding is obtainable.

## 8 inch coloured touch Screen

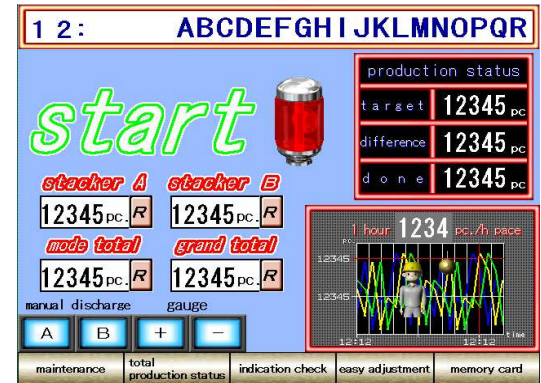

▲Operation display  
 Production status can be confirmed, too.

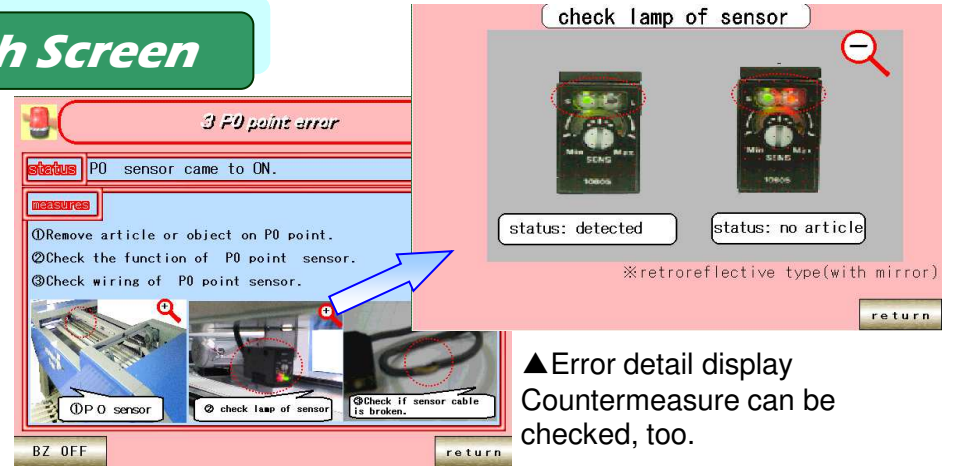

▲Error display  
 Detail of error is indicated with photo.  
 ▲Error detail display  
 Countermeasure can be checked, too.

## Folding for spa uniform

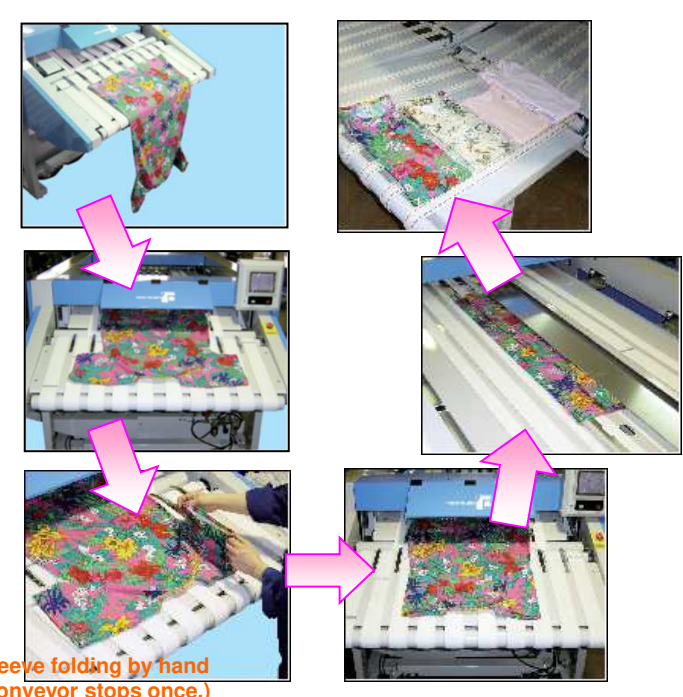

Sleeve folding by hand (conveyor stops once.)

## Adjustment of folding

Finishing quality can be adjusted finely through touch panel. Picture shows you which parameter should be changed.

